

# FIRST IN WEIGHT DISTRIBUTION



### Reese® Strait-Line™ Hitch & Dual Cam High Performance Sway Control

The ultimate hitch in detail and design. The Strait-Line Hitch consists of our patented Dual Cam High-Performance Sway Control and our High-Performance Weight Distributing System in one easy-to-install package.

- Pro-active design forces the trailer to stay in a straight line behind your tow vehicle.
- The stronger the sway force, the more the Dual Cam HP works to stop it.
- Simple installation and adjustment
- Fully automatic and self-centering
- Rated up to 1,700 lbs. TW and 17,000 lbs. GTW
- Limited lifetime warranty



### Reese SC Sway Control Hitch Kits

This system offers the functionality of a weight distribution system with friction sway control built in.

- Tapered bars provide superior weight distribution performance over a variety of uneven road and weather conditions
- Integrated friction sway control provides consistent control
- Rated up to 1,500 lbs. TW and 15,000 lbs. GTW
- Limited lifetime warranty



### Reese Weight Distribution Round Bar Style

The Round Bar Weight Distributing Hitch features easy-to-use adjusting blocks for easier and faster ball mount angle adjustment.

- One-piece cast head, snap-up brackets & chains
- Adjusting washers for head adjustment
- Rated up to 1,200 lbs. TW and 12,000 lbs. GTW
- Limited lifetime warranty



### Reese Weight Distribution Trunnion Style

Reese® has combined the best of the features from all of our weight distributing kits to create the High-Performance Trunnion Kit.

- Raised hitch ball platform

- Serrated washers for head adjustment
- Forged ball platform and spring bar mounts
- Rated up to 1,700 lbs. TW and 17,000 lbs. GTW
- Limited lifetime warranty



## TO DETERMINE THE CORRECT WEIGHT DISTRIBUTING HITCH:

1. Determine the tongue weight of your trailer
2. Estimate the vehicle cargo load
3. Match the sum of these weights to the proper Reese® hitch.

## HITCH WEIGHT = TONGUE WEIGHT + VEHICLE CARGO LOAD BEHIND REAR AXLE

Tongue weight includes the trailer tongue weight with full gas, water and waste systems and everything packed inside the trailer. Vehicle cargo includes all materials carried in your tow vehicle, such as boat motors, gas cans, tools, etc.

### EXAMPLE:

TONGUE WEIGHT 500 LBS.  
 PLUS VEHICLE CARGO LOAD + 200 LBS.  
 TOTAL HITCH WEIGHT = 700 LBS.

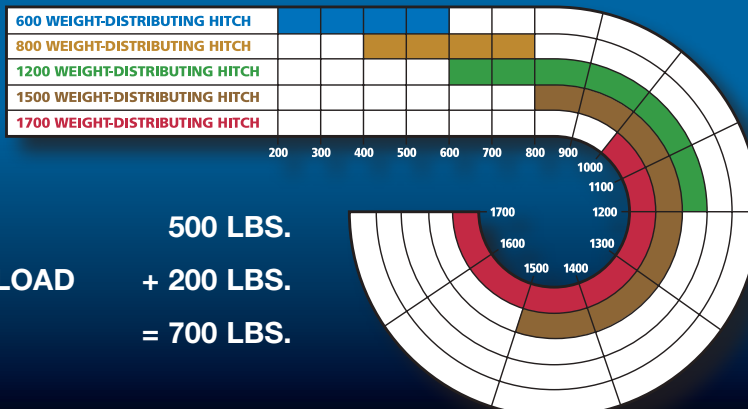

USING THE SELECTOR SHOWN ABOVE, AN 800 WEIGHT-DISTRIBUTING HITCH IS ADEQUATE.

# WEIGHT DISTRIBUTION SYSTEMS

## WEIGHT DISTRIBUTION SYSTEMS

Cequent Weight Distribution Systems

Reese® Strait-Line® System

Reese® SC Hitch Kits

Reese® Trunnion Style Weight Distribution

Reese® Round Bar Style Weight Distribution

Reese® Titan® Weight Distribution

Reese® Light Duty Weight Distribution Kit

Reese® 350 Mini-Lite Weight Distribution Kit

Draw-Tite® Trunnion Style Weight Distribution

Draw-Tite® Round Bar Style Weight Distribution

Pro Series™ Complete Round Bar Weight Distribution

Pro Series™ Trunnion Style Weight Distribution

Pro Series™ RB2 Weight Distribution

Pro Series™ RB3 Weight Distribution

## SWAY CONTROLS

Reese® Dual Cam Sway Control

Reese® Friction Sway Control

Draw-Tite® Dual Cam Sway Control

Draw-Tite® Friction Sway Control

Pro Series™ Friction Sway Control

## WEIGHT DISTRIBUTION ACCESSORIES

Hitch Bars

Chain Hangers

Snap Up Brackets



## WEIGHT DISTRIBUTION SYSTEMS

**Add a weight distributing system to provide a more level ride, greater steering and brake control.**

### THE DIFFERENCES ARE IN

construction materials, welding, manufacturing processes and hook-up. Adjustment is simple because of the easy-to-operate snap-up brackets that allow spring bar tension to be adjusted by changing links in the support chains. Rather than merely supporting the trailer tongue weight (TW), weight-distributing hitches apply leverage between the towing vehicle and trailer causing the TW to be carried by all axles of the tow vehicle and trailer.

A Weight Distributing Hitch System is composed of four major elements:

1. the hitch receiver
2. the weight distribution kit
3. the hitch ball
4. the sway control (see below)

They work in unison to provide complete towing system compatibility.

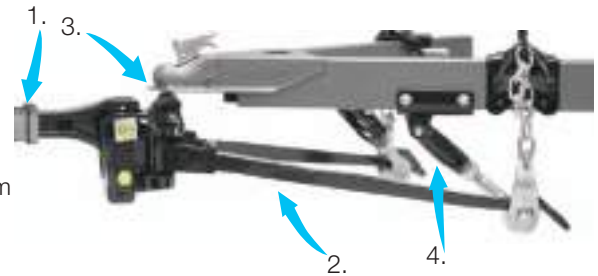

*without weight distributing*



*with weight distribution*

## Dual Cam HP

### SWAY CONTROL

Premier Sway Control – Unlike the friction sway control, the Dual Cam HP™ has the ability to forestall sway from the start in addition to resisting sway once it's begun. Works only when needed and allows free and easy vehicle/trailer interaction. Installs on the trailer and therefore doesn't require adjustment every time the tow vehicle and trailer are hooked up, unless ball mount height angle or the number of working chain links are changed.

- Integrated cams in the spring bars reduce noise
- No U-bolts to conflict with bottle racks or other A-frame mounted items
- Specific attachment reference points provided
- Simple, easy adjustment of centerline
- Fits more applications
- Improved installation times
- Years of extensive field testing



## WHY CHOOSE OUR WEIGHT DISTRIBUTING?

We have been the leader in weight distributing systems for more than 55 years. Over those years, much has changed within the industries we serve. Tow vehicles and their frames have been made lighter while the trailers have become heavier. The technology utilized yesterday can no longer be used in today's world.

**This is why we have been the leader in weight distributing systems for over 55 years.**



## QUALITY RAW MATERIALS

- Specially formulated bar stock is specified from the steel mill to meet demanding standards
- Inspected for adherence to specifications prior to being released to manufacturing



## QUALITY MANUFACTURING PROCESS

- Thermal induction heating prepares the bar stock to be hot-rolled and tapered
- Hot-rolling/tapering (not forging) allows us to control the molecular structure in the steel to give it the desired strength and flexibility
- Austempering heat treat changes the chemical makeup (hardness) of the steel and transforms the raw stock into a spring bar

## QUALITY TESTING

- Spring bars are tested for flexibility and its ability to accept deflection without bending or breaking.
- Rockwell hardness tests are performed to ensure that the raw stock has been transformed into a spring bar.



*Round Style Spring Bars*

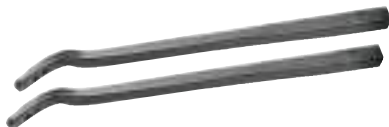

*Trunnion Style Spring Bars*

## WE ARE THE INDUSTRY STANDARD IN SPRING BARS

## STRAIT-LINE® SYSTEM

This is the ultimate hitch in detail and design. No other hitch gives the driver the control this one does at a reasonable price. The Strait-Line® Hitch consists of our patented Dual Cam High-Performance Sway Control and our High-Performance Weight Distributing System in one easy-to-install package.

The Strait-Line® Hitch was given this name as its pro-active design literally forces the trailer to stay in a straight line behind the tow vehicle. Sway is controlled by the Dual Cam High-Performance System. The stronger the sway force, the more the Dual Cam System works to stop it.

The Strait-Line® Hitch combines weight distributing with the best proven pro-active sway control system available in a newly-designed, easy-to-install kit.

- Simple installation and adjustment
- Fully automatic and self-centering
- Hooking up spring bars automatically hooks up sway control
- Reduced noise
- No U-bolts to interfere with bottle racks or other A-frame mounted items
- Specific attachment reference points provided
- Easy adjustment of centerline
- No need to relocate items on top of A-frame to install Dual Cam High-Performance Sway Control
- Limited lifetime warranty

### STRAIT-LINE® TRUNNION BAR HITCH W/O HITCH BAR

Part No.	Description
66072	Strait-Line® 600 Trunnion Bar (includes 66020 & 26002)
66073	Strait-Line® 800 Trunnion Bar (includes 66021 & 26002)
66074	Strait-Line® 1200 Trunnion Bar (includes 66022 & 26002)
66130	Strait-Line® 1500 Trunnion Bar for Ultra Frame® receivers (includes 66131 & 26002)
66075	Strait-Line® 1700 Trunnion Bar for Titan® receivers (includes 66006 & 26002)

### STRAIT-LINE® TRUNNION BAR HITCH W/HITCH BAR #54970

Part No.	Description
66082	Strait-Line® 600 Trunnion Bar w/Hitch Bar (includes 66540 & 26002)
66083	Strait-Line® 800 Trunnion Bar w/Hitch Bar (includes 66541 & 26002)
66084	Strait-Line® 1200 Trunnion Bar w/Hitch Bar (includes 66542 & 26002)

### STRAIT-LINE® ROUND BAR HITCH W/O HITCH BAR

Part No.	Description
66076	Strait-Line® 600 Round Bar (includes 66065 & 26002)
66077	Strait-Line® 800 Round Bar (includes 66066 & 26002)
66078	Strait-Line® 1200 Round Bar (includes 66067 & 26002)

### STRAIT-LINE® ROUND BAR HITCH W/HITCH BAR #54970

Part No.	Description
66086	Strait-Line® 600 Round Bar w/Hitch Bar (incl 65509 & 26002)
66087	Strait-Line® 800 Round Bar w/Hitch Bar (incl 67509 & 26002)
66088	Strait-Line® 1200 Round Bar w/Hitch Bar (incl 61009 & 26002)





The best integrated friction control system on the market with 6 points of true friction control.



**REESE® SC HITCH KITS**

- Ratings 600/800/1200/1500 lbs. with hitch bar #54970
- Integrated friction sway control with automotive friction material as used on vehicle brakes – sway control provides consistent control in various weather conditions
- Reese® style serrated washer system allows for easy head adjustment - does not require head removal for washer adjustment
- Raised hitch ball platform
- Clamp on brackets and adjustable pad hangers allow for placement on trailer frames without removing the gas bottles/batteries
- Lift handle accessory included to reduce the amount of lifting required by the trailer jack when preloading the WD system
- Tapered spring bars with preassembled trunnions reduce install time
- Tapered bars provide superior weight distribution performance over a variety of uneven road and weather conditions
- Proven durability
- Limited lifetime warranty

**Four easy steps to hook up the Spring Bar**

**Step 1:**

Place spring bar and lift handle onto clamp-on bracket



**Step 2:**

Rotate lift handle upward



**Step 3:**

Remove lift handle



**Step 4:**

Close and secure lid with pin



**REESE® SC w/HITCH BAR #54970**

Part No.	Description	Gross Trailer Wt.	Tongue Wt.
66151	Weight Distributing Hitch	10,000 lbs.	600 lbs.
66153	Weight Distributing Hitch	10,000 lbs.	800 lbs.
66155	Weight Distributing Hitch	12,000 lbs.	1,200 lbs.
66157	Weight Distributing Hitch	15,000 lbs.	1,500 lbs.

**REPLACEMENT PARTS**

Part No.	Description
58356	600 lbs. Trunnion Spring Bar
58357	800 lbs. Trunnion Spring Bar
58358	1,200 lbs. Trunnion Spring Bar
58359	1,500 lbs. Trunnion Spring Bar



**TRUNNION STYLE**

Reese® has combined the best of the features from all of our weight distributing kits to create the High-Performance Trunnion Kit. It includes a head design with superior strength and easy adjustment.

The head includes a forged raised ball platform and forged Trunnion mounts. The channel of the head utilizes our “serrated washer” design. The serrated washers make it easier to dial in the set up of the High-Performance Weight Distributing Kit.

In addition to the changes in the head, the High-Performance Weight Distributing Kit includes the highest rated spring bars per class in the industry. They also feature an integrated cam for easy set up with the optional Dual Cam High-Performance Sway Control. Other features include 9-link chains for easier set up on larger trailer frames and innovative snap-up brackets designed for superior strength and durability.

- Raised hitch ball platform eliminates the need for raised hitch balls
- Easy-to-use serrated washers for head adjustment
- Forged ball platform and spring bar mounts
- Rated up to 15,000 lbs. GTW and 1,500 lbs. TW
- Limited lifetime warranty

**PATENTED INNOVATIVE DESIGN**

*Easy-to-use serrated washer*

*Raised hitch ball platform eliminates the need for raised hitch balls*

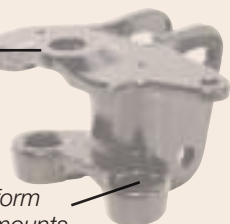

*Forged ball platform and spring bar mounts*

**PATENTED INNOVATIVE DESIGN**

*Forged integrated cam*

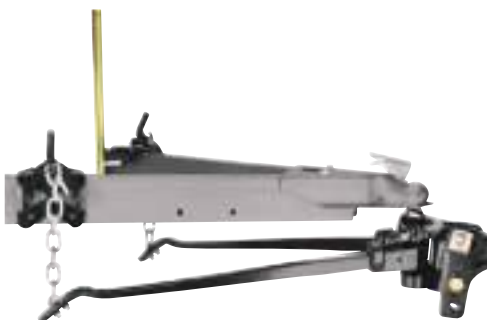

**WEIGHT DISTRIBUTION W/O HITCH BAR**

Part No.	Description	Gross Trailer Wt.	Tongue Wt.
66020	Weight Distributing Hitch	10,000 lbs.	600 lbs.
66021	Weight Distributing Hitch	10,000 lbs.	800 lbs.
66022	Weight Distributing Hitch	12,000 lbs.	1,200 lbs.
66131*	Weight Distributing Hitch	15,000 lbs.	1,500 lbs.

*U.S. Patent Nos. 5,375,867 and 5,465,991, other patents pending  
\* Designed to be used with Ultra Frame® receiver*

**WEIGHT DISTRIBUTION W/HITCH BAR #54970**

Part No.	Description	Gross Trailer Wt.	Tongue Wt.
66540	Weight Distributing Hitch	10,000 lbs.	600 lbs.
66541	Weight Distributing Hitch	10,000 lbs.	800 lbs.
66542	Weight Distributing Hitch	12,000 lbs.	1,200 lbs.

*U.S. Patent Nos. 5,375,867 and 5,465,991, other patents pending*

**REPLACEMENT PARTS**

Part No.	Description
58167	Adjustable Ball Mount w/hardware
22225	800 lbs. Trunnion Spring Bar
66009	1,200 lbs. Trunnion Spring Bar
58369	1,500 lbs. Trunnion Spring Bar
6637	Snap Up Bracket Assembly Kit w/handle (2-piece)
21501	Snap Up Bracket Assembly
58392	Snap Up Bracket for Titan® or Ultra Frame®
58207	Ball Mount Shim Kit





**ROUND BAR STYLE**

The Round Bar Weight Distributing Hitch features easy-to-use adjusting blocks for easier and faster ball mount angle adjustment. It includes a one-piece cast head, snap-up brackets and chains; spring bars include an integrated cam for use with optional dual cam sway control.

In addition to the changes in the head, the Round Bar Weight Distributing Kit includes the highest rated spring bars per class in the industry. They also feature an integrated cam for easy set up with the optional Dual Cam High-Performance Sway Control. Other features include 9-link chains for easier set up on larger trailer frames and innovative snap-up brackets designed for superior strength and durability.

- Easy-to-use adjusting washers for head adjustment
- One piece cast head
- Rated up to 12,000 lbs. GTW and 1,200 lbs. TW
- Limited lifetime warranty



**PATENTED INNOVATIVE DESIGN**  
Easy-to-use adjusting washer

One piece cast head

Integrated right hand sway control platform

**PATENTED INNOVATIVE DESIGN**  
Forged integrated cam



**WEIGHT DISTRIBUTION W/O HITCH BAR**

Part No.	Description	Gross Trailer Wt.	Tongue Wt.
66065	Weight Distributing Hitch	10,000 lbs.	600 lbs.
66066	Weight Distributing Hitch	10,000 lbs.	800 lbs.
66067	Weight Distributing Hitch	12,000 lbs.	1,200 lbs.

**WEIGHT DISTRIBUTION W/HITCH BAR #54970**

Part No.	Description	Gross Trailer Wt.	Tongue Wt.
65509	Weight Distributing Hitch	10,000 lbs.	600 lbs.
67509	Weight Distributing Hitch	10,000 lbs.	800 lbs.
61009	Weight Distributing Hitch	12,000 lbs.	1,200 lbs.

**REPLACEMENT PARTS**

Part No.	Description
58112	Adjustable Ball Mount w/hardware
58113	600 lbs. Round Spring Bar
58114	800 lbs. Round Spring Bar
58115	1,200 lbs. Round Spring Bar
6637	Snap Up Bracket Assembly Kit w/handle (2-piece)
21501	Snap Up Bracket Assembly
58207	Ball Mount Shim Kit



58112



58113

58114

58115



6637





**TITAN® WEIGHT DISTRIBUTING TRUNNION STYLE**

Designed for loads beyond normal everyday towing situations, Titan® Weight Distributing Hitch system provides a trunnion design with the highest rating available in the towing industry. Coupled with a 2-1/2" Class V Titan® receiver, heavy loads are transported with ease. Ideal for commercial and industrial use.



- Trunnion style weight distributing kit with integrated cams for use with Dual Cam Sway Control
- Perfect for use with horse trailers and RV's with heavy tongue weights
- Adjustable hitch bar sold separately
- Great for agricultural, marine and recreational use
- Limited lifetime warranty

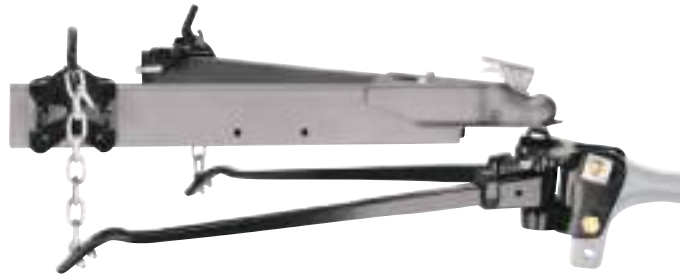

**TITAN® WEIGHT DISTRIBUTING TRUNNION STYLE W/O HITCH BAR**



54977

Part No.	Description	Gross Trailer Wt.	Tongue Wt.
<b>66006</b>	Weight Distributing Hitch	17,000 lbs.	1,700 lbs.

*Note: Do not exceed tow vehicle, hitch or equipment ratings.*

**TITAN® HITCH BAR SELECTION CHART**

Part No.	Total Ht Adj	Length (L)	Rise (R)	Drop (D)	GTW/TW (lbs.)
<b>54976</b>	6-1/4"	15"	5-1/4"	1-1/4"	17,000/1,700
<b>54977</b>	14-1/4"	15"	8-1/4"	5-3/4"	17,000/1,700

*NOTE: Do not exceed tow vehicle, hitch or equipment rating*

**REPLACEMENT PARTS**



58167

Part No.	Description
<b>58167</b>	Titan® Trunnion Bolt-Together Head Kit w/ hardware
<b>58392</b>	Snap Up Bracket for Titan® or Ultra Frame®



**LIGHT DUTY WEIGHT DISTRIBUTING KIT**

This light-duty weight distributing system is especially designed for use with lighter-weight trailers and pop-up campers. The center mount single bar is contoured to avoid interference with center-mounted jacks. The lift mechanism is designed to prevent interference with gas bottles or battery trays. It's easy to set up and use, and works with any 2" receiver.

The integrated lift bar feature provides the advantage of allowing a single person to operate from one side of the trailer. This system works with both side and center mounted tongue jacks. The sway control platform allows you to put a friction sway control on either side of the trailer.



Does not include hitch ball

Adjuster slides on frame to avoid gas bottles and battery trays; slides adjust 18 to 28 inches

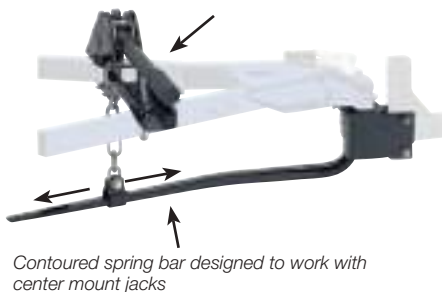

- Bolt-together welded head
- Integral sway control platform
- Innovative single spring bar design
- Assembly hardware and chains included
- Rated up to 4,000 lbs. GTW /400 lbs. TW
- Works with both side and center mount tongue jacks

Part No.	Description
66071	Light Duty WD for Pole Tongue Trailers
66069	Light Duty WD for A-Frame Trailers

\*Note: Not recommended for use with surge brakes

**350 MINI-LITE WEIGHT DISTRIBUTING KIT**

This weight-distributing system is especially designed for use with light-weight trailers and fold-down campers. No chains or snap-up brackets are necessary and the 350 Mini-Lite works with any 2" receiver.

**TRUNNION STYLE**

- Hitch ball included
- Maximum tongue weight capacity of 350 lbs.
- Gross trailer weight of 3,500 lbs.

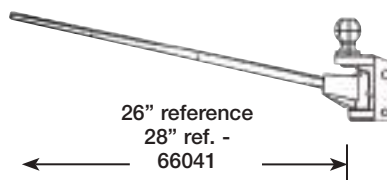

Mounts on "A" frame of trailer 26" back from center line of ball.

Part No.	Description
66024	Weight Distributing with 2" hitch ball; includes hitch ball, -adjustable hitch bar, spring bars, pins and wear pads
66041	Weight Distributing for Fleetwood/Coleman trailers with side-mounted swing-away jack; includes 2" Hitch Ball, Adjustable Hitch Bar, Spring Bars, pins and wear pads
54985	Tall Adjustable Hitch Bar for Mini Weight Distributing Hitch



## TRUNNION STYLE

Draw-Tite® has combined the best of the features from all of our weight distributing kits to create the Trunnion Kit. It includes a head design with superior strength and easy adjustment.

The head includes a forged raised ball platform and forged Trunnion mounts. The channel of the head utilizes our “serrated washer” design. The serrated washers make it easier to dial in the set up of the Weight Distributing Kit.

In addition to the changes in the head, the Weight Distributing Kit includes the highest rated spring bars per class in the industry. They also feature an integrated cam for easy set up with the optional Dual Cam High-Performance Sway Control. Other features include 9-link chains for easier set up on larger trailer frames and innovative snap-up brackets designed for superior strength and durability.



### PATENTED INNOVATIVE DESIGN

Easy-to-use serrated washer

Raised hitch ball platform eliminates the need for raised hitch balls

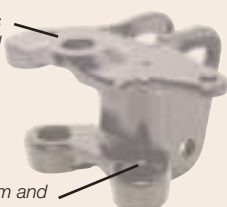

Forged ball platform and spring bar mounts

### PATENTED INNOVATIVE DESIGN

Forged integrated cam



- Raised hitch ball platform eliminates the need for raised hitch balls
- Easy-to-use serrated washers for head adjustment
- Forged ball platform and spring bar mounts
- Rated up to 15,000 lbs. GTW and 1,500 lbs. TW
- Limited lifetime warranty



## WEIGHT DISTRIBUTION W/O HITCH BAR

Part No.	Description	Gross Trailer Wt.	Tongue Wt.
7901	Weight Distributing Hitch	10,000 lbs.	600 lbs.
7902	Weight Distributing Hitch	10,000 lbs.	800 lbs.
7903	Weight Distributing Hitch	12,000 lbs.	1,200 lbs.
66131*	Weight Distributing Hitch	15,000 lbs.	1,500 lbs.

\* Designed to be used with Ultra Frame® receiver

## REPLACEMENT PARTS

Part No.	Description
6637	Snap Up Bracket Assembly Kit (qty 2) w/handle
21501	Snap Up Bracket Assembly (qty 1)
62167	Bolt together single ear head assembly & hardware
6664	800 lbs. trunnion spring bars (qty 2), chains & fasteners
6666	1,200 lbs. trunnion spring bars (qty 2), chains & fasteners
58369	1,500 lbs. trunnion spring bars (qty 1), chains & fasteners
58392	Snap Up Bracket for Titan® or Ultra Frame®



62167



## ROUND BAR STYLE

The Round Bar Weight Distributing Hitch features easy-to-use adjusting blocks for easier and faster ball mount angle adjustment. It includes a one-piece cast head, snap-up brackets and chains; spring bars include an integrated cam for use with optional dual cam sway control.

In addition to the changes in the head, the Round Bar Weight Distributing Kit includes the highest rated spring bars per class in the industry. They also feature an integrated cam for easy set up with the optional Dual Cam High-Performance Sway Control. Other features include 9-link chains for easier set up on larger trailer frames and innovative snap-up brackets designed for superior strength and durability.



### PATENTED INNOVATIVE DESIGN

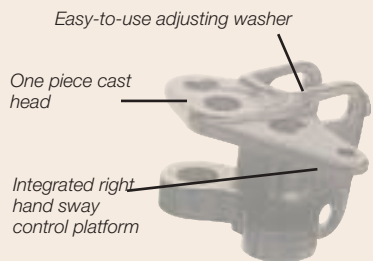

### PATENTED INNOVATIVE DESIGN



- Easy-to-use adjusting washers for head adjustment
- One piece cast head
- Rated up to 12,000 lbs. GTW and 1,200 lbs. TW
- Limited lifetime warranty



## WEIGHT DISTRIBUTION W/O HITCH BAR

Part No.	Description	Gross Trailer Wt.	Tongue Wt.
3201	Weight Distributing Hitch	10,000 lbs.	600 lbs.
3202	Weight Distributing Hitch	10,000 lbs.	800 lbs.
3203	Weight Distributing Hitch	12,000 lbs.	1,200 lbs.

## REPLACEMENT PARTS

Part No.	Description
6637	Snap Up Bracket Assembly Kit (qty 2) w/handle
21501	Snap Up Bracket Assembly (qty 1)
62112	Bolt together head assembly & hardware
62113	600 lbs. round spring bar (qty 1)
62114	800 lbs. round spring bar (qty 1)
62115	1,200 lbs. round spring bar (qty 1)





**PRO SERIES™ COMPLETE ROUND BAR KIT**

The innovative Pro Series™ Complete Round Bar weight distribution is engineered to provide the features you expect in a weight distribution kit at an economical price.

- Provides everything needed to improve towing, safety and performance right out of the box
- Preinstalled and torqued sway control ball and 2-5/16" hitch ball, u-bolts and chains
- Fabricated head and welded hitch bar
- Includes friction sway control and mounting hardware
- 10 year warranty
- Available in 550/750/1,000 lbs kits



Part No.	Description	Gross Trailer Wt.	Tongue Wt.
49901	Pro Series™ Complete Round Bar WD Kit	10,000 lbs.	550 lbs.
49902	Pro Series™ Complete Round Bar WD Kit	10,000 lbs.	750 lbs.
49903	Pro Series™ Complete Round Bar WD Kit	10,000 lbs.	1,000 lbs.

*Note: Minimum purchase requirements for these products. Please contact your Cequent Performance Products sales representative for further details.*

**REPLACEMENT PARTS**

Part No.	Description
58444	Pro Series™ Ball Mount Shim Kit

**PRO SERIES™ TRUNNION STYLE**

The innovative Pro Series™ Trunnion weight distribution is engineered to provide the features you expect in a weight distribution kit at an economical price.

- New combination single piece cast head
- Easy to use adjusting washers
- Unique washer design allows for quick spring bar tension adjustment
- Round tapered spring bars
- Head is compatible with optional Friction Sway Control (each side)
- Includes hitch bar #63970
- 10 year limited warranty



**WEIGHT DISTRIBUTION w/HITCH BAR #63970**

Part No.	Description	Gross Trailer Wt.	Tongue Wt.
49585	Weight Distributing Hitch	10,000 lbs.	600 lbs.
49586	Weight Distributing Hitch	10,000 lbs.	800 lbs.
49587	Weight Distributing Hitch	12,000 lbs.	1,200 lbs.

Available in skid quantities of 20. (Example: 49585-020)



**PRO SERIES™ RB2**

The innovative Pro Series™ Round Bar weight distribution is engineered to provide the features you expect in a weight distribution kit at an economical price.



- New combination single piece cast head
- Easy to use adjusting washers
- Unique washer design allows for quick spring bar tension adjustment
- Head is compatible with optional Friction Sway Controls (each side)
- Includes hitch bar #63970
- 10 year limited warranty



**WEIGHT DISTRIBUTION w/HITCH BAR #63970**

Part No.	Description	Gross Trailer Wt.	Tongue Wt.
49568	Weight Distributing Hitch	10,000 lbs.	600 lbs.
49569	Weight Distributing Hitch	10,000 lbs.	800 lbs.
49570	Weight Distributing Hitch	12,000 lbs.	1,200 lbs.

Available in skid quantities of 20. (Example: 49570-020)

**PRO SERIES™ RB3**

- Fabricated head and welded hitch bar
- Available in 550/750/1,000 lbs kits
- Head is compatible with optional Friction Sway controls (each side)
- 10 year limited warranty



**WEIGHT DISTRIBUTION w/HITCH BAR**

Part No.	Description	Gross Trailer Wt.	Tongue Wt.
49581	Weight Distributing Hitch	10,000 lbs.	550 lbs.
49582	Weight Distributing Hitch	10,000 lbs.	750 lbs.
49583	Weight Distributing Hitch	10,000 lbs.	1,000 lbs.

Available in skid quantities of 20. (Example: 49583-020)



54980

### ADJUSTABLE BALL MOUNTS W/ HITCH BARS

Part No.	Description
54980	Complete Adjustable Ball Mount with 54970 Hitch Bar

### Dual Cam HP



### DUAL CAM HIGH-PERFORMANCE SWAY CONTROL

This patented product is Reese® Products main technique for controlling trailer sway. Unlike Friction Sway Control, this approach works to control sway from the start rather than just resisting sway once it's begun. And it works only when needed. The advantage of the Dual Cam System is its ability to forestall sway in addition to sway resistance. It works to hold down the start of swaying activity while at the same time allowing free and easy vehicle and trailer interaction. Another advantage of the Dual Cam System is that it is installed on the trailer and therefore does not require adjustment every time the towing vehicle and trailer are hooked up, unless hitch weight or tow vehicle loading are changed.

- Integrated cams into the spring bars reduce noise
- No U-bolts to interfere with bottle racks or other A-frame mounted items
- Specific attachment reference points provided
- Fits most applications
- Improved installation times
- Years of extensive field testing



26002

Part No.	Description
26025	Classic Dual Cam High Performance Sway Control
26002	Dual Cam High Performance Sway Control

*Weight distributing hitch not included; use of sway controls with surge brakes not recommended; this product is recommended to be used with weight distribution that has the integrated spring bars only*



3442



58060

### FRICITION SWAY CONTROL

- Installs and removes easily
- Removes with two spring locking pins
- Heavy construction for added reliability
- Friction brake keeps trailer and tow vehicle stable
- Quick attachment to trailer frame and ball mount
- Can be used on left and right side of trailer



26660

Part No.	Description
26660	Sway Control Assembly and fasteners - (boxed)
3442	Weld-on Sway Control adapter
58060	Replacement Sway Control ball 1-1/4" x 5/8"
58062	Replacement Ball Plate Assembly

*Weight distributing hitch not included; use of sway controls with surge brakes is not recommended*

# Dual Cam HP



26102



3442



58060



3400



58062



58060



26003  
26005

## DUAL CAM HIGH-PERFORMANCE SWAY CONTROL



This patented product is Draw-Tite's main technique for controlling trailer sway. Unlike Friction Sway Control, this approach works to control sway from the start rather than just resisting sway once it's begun. And it works only when needed. The advantage of the Dual Cam System is its ability to forestall sway in addition to sway resistance. It works to hold down the start of swaying activity while at the same time allowing free and easy vehicle and trailer interaction. Another advantage of the Dual Cam System is that it is installed on the trailer and therefore does not require adjustment every time the towing vehicle and trailer are hooked up, unless hitch weight or tow vehicle loading are changed.

- Integrated cams into the spring bars reduce noise
- No U-bolts to interfere with bottle racks or other A-frame mounted items
- Specific attachment reference points provided
- Fits most applications
- Improved installation times
- Years of extensive field testing

Part No.	Description
26015	Classic Dual Cam High Performance Sway Control
26102	Dual Cam High Performance Sway Control

*Note: Weight distributing hitch not included; use of sway controls with surge brakes not recommended; this product is recommended to be used with weight distribution that has the integrated spring bars only.*

## FRICTION SWAY CONTROL

- Installs and removes easily
- Removes with two spring locking pins
- Heavy construction for added reliability
- Friction brake keeps trailer and tow vehicle stable
- Quick attachment to trailer frame and ball mount
- Can be used on left and right side of trailer



Part No.	Description
3400	Sway Control Assembly and fasteners - (boxed)
3442	Weld-on Sway Control adapter
58060	Replacement Sway Control ball 1-1/4" x 5/8"
58062	Replacement Ball Plate Assembly

*Note: Weight distributing hitch not included; use of sway controls with surge brakes is not recommended.*



Part No.	Description
83660	Pro Series Friction Sway Control
3442	Weld-on Sway Control adapter
58060	Replacement Sway Control ball 1-1/4" x 5/8"
58062	Replacement Ball Plate Assembly

*Note: Weight distributing hitch not included; use of sway controls with surge brakes is not recommended.*

## BOLT-ON MOUNTING ADAPTERS FOR SWAY CONTROL

- Easy bolt-on installation
- Bulk packaged
- Black powder coat finish over e-coat

Part No.	Description
26003	Sway Control Adapter Bracket for Class III & IV 2" ball mounts
26005	Sway Control Adapter Bracket for Class II 1-1/4" drawbars

*26003 cannot be used with Class I or Class II Drawbars.*

*26005 cannot be used with Class I Drawbars.*

*Ball platform does not prevent adapter from turning during tightening.*



**WEIGHT DISTRIBUTING HITCH BARS**

Sold separately from the Weight Distributing Hitch Kits, hitch bars offer a full range of style and adjustability. Designed for use with all Trunnion and Round Bar Weight Distributing Kits.

- Angled, extended, "T" and deep drop designs available
- Designed for use in the rise or drop position
- 2" x 2" solid shanks
- Black powder coat finish over over e-coat

**HOW TO MEASURE FOR THE PROPER HITCH BAR**

Refer to the diagrams below to assist in determining the correct Length, Rise & Drop required when selecting the correct hitch bar for your Weight Distributing Hitch.

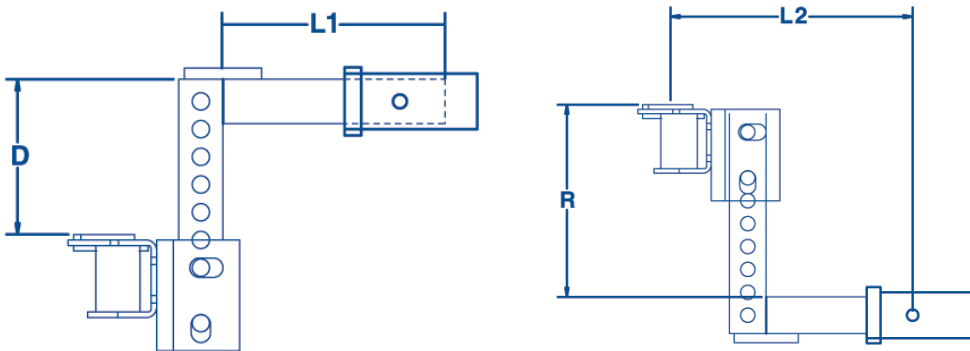

*Illustrations show Adjustable Hitch Bar*



Part No	Style	Shank Size	Capacity lbs. (TW)	Shank bar Length (L1)	Length(L2) Round	Trunnion	Drop (D) Round	Trunnion	Rise(R) Round	Trunnion
54985	4	2"	350	12-1/2"	N/A	14-3/8"	N/A	6"	N/A	9-1/2"
3210	1	2"	1,400	10"	12-1/2"	11-7/8"	2-1/4"	1-1/4"	5-3/4"	7"
3212	1	2"	1,400	12"	14-1/2"	13-7/8"	2-1/4"	1-1/4"	5-3/4"	7"
3214	1	2"	1,400	14"	16-1/2"	15-7/8"	2-1/4"	1-1/4"	5-3/4"	7"
3215	2	2"	1,400	11"	13-1/2"	12-7/8"	6-3/4"	5-3/4"	10-1/4"	11-1/2"
3344	3	2"	1,400	11"	13-1/2"	12-7/8"	8-5/8"	7-5/8"	N/A	N/A
54970	4	2"	1,500	12-1/4"	14-3/4"	14"	2"	1-1/4"	5-1/4"	6-1/2"
63970	4	2"	1,500	12-1/4"	14-3/4"	14"	2"	1-1/4"	5-1/4"	6-1/2"
63971	5	2"	1,500	12-1/2"	15"	14-3/8"	6-1/2"	5-3/4"	N/A	N/A
54976	4	2-1/2"	1,700	15"	N/A	16-7/8"	N/A	1-1/4"	N/A	6-1/2"
54977	6	2-1/2"	1,700	15"	N/A	16-7/8"	N/A	5-3/4"	N/A	10-1/2"

NOTE: Do not exceed tow vehicle, hitch or equipment rating



5780

**LOAD-MASTER TRAILER TONGUE WEIGHT SCALE**

- Load-Master is a hydraulic pressure gauge for measuring trailer tongue weights from 0 to 2,000 lbs.

Part No.	Description
5780	Load-Master Trailer Tongue Weight Scale



3280

**POLE TONGUE ADAPTER**

A Pole Tongue Adapter is used as a mounting platform for the Lift Brackets of a Weight Distributing Hitch System when a trailer has a pole or straight tongue rather than an A-frame tongue.

- Fits all lift units regardless of manufacturer
- Fits tongue widths from 1-5/8" to 5"
- Fits tongue heights from 3" to 6"

Part No.	Description	Gross Trailer Wt.	Tongue Wt.
3280	Pole Tongue Adapter and Fastener Kit	7,500 lbs.	750 lbs.
58393	Pole Tongue Adapter and Fastener Kit	14,000 lbs.* 12,000 lbs.**	1400 lbs.* 1200 lbs.**

*Note: Not for use with light duty weight distributing hitch*

*\* When mounted on top of the tongue*

*\*\* When mounted below the tongue*

**WEIGHT DISTRIBUTING CHAIN HANGERS**

For trailers with tongue interference (gas bottles, batteries, covered frames, etc.) where snap up brackets (#21501) won't install easily, we offer two easy-to-install options.



58305



58306



- Black powder coat finish over e-coat
- Installs quickly! (approximately 15 minutes)
- Includes hardware

Part No.	Description	Gross Trailer Wt.	Tongue Wt.
58305	Chain Hanger, Bolt On	14,000 lbs.	1400 lbs.
58306	Chain Hanger, Clamp On	14,000 lbs.	1400 lbs.



21501

**WEIGHT DISTRIBUTING SNAP UP BRACKETS**

- Rugged positive locking design
- Unit locks using safety pin (#55180)
- Narrower, for increased frame clearance
- One-piece cast chain hook
- Black powder coat finish over e-coat

Part No.	Description
6637	Snap Up Bracket Assembly Kit w/handle (2- piece)
21501	Snap Up Bracket
58162	Snap Up Handle
58392	Snap Up Bracket for Titan® or Ultra Frame®